

INW 01-84_Einstufige Verdichter / Vakuumpumpen mit Seiten kanal

Maßangaben

| Baureihe | A | B | C | D | E | F | G | H | J | K | L | M | N | O | P | Q |
|------------|-----|-----|-----|-----|-----|-----|-----|-----|-----|-----|-----|-----|-----|----|-------|----|
| INW 01 | 190 | 203 | 72 | 155 | 172 | 242 | 124 | 102 | 101 | 80 | 101 | 108 | 53 | 30 | G 1" | 46 |
| INW 11 | 213 | 225 | 76 | 155 | 172 | 242 | 124 | 114 | 101 | 80 | 101 | 111 | 52 | 33 | G 1" | 46 |
| INW 21 A11 | 246 | 247 | 90 | 205 | 230 | 256 | 133 | 128 | 111 | 83 | 108 | 75 | 71 | 39 | G 1¼" | 64 |
| INW 21 H06 | | | | | | 219 | 92 | | 101 | | | | | | | |
| INW 21 H16 | | | | | | 256 | 129 | | 111 | | | | | | | |
| INW 31 | 261 | 266 | 101 | 206 | 228 | 245 | 129 | 140 | 111 | 83 | 105 | 75 | 71 | 42 | G 1¼" | 68 |
| INW 41 A01 | 285 | 302 | 115 | 225 | 255 | 269 | 129 | 154 | 120 | 95 | 130 | 70 | 75 | 46 | G 1½" | 68 |
| INW 41 A11 | | | | | | 292 | 156 | | | | | | | | | |
| INW 41 A21 | | | | | | | | | | | | | | | | |
| INW 41 H06 | | | | | | 269 | 129 | | | | | | | | | |
| INW 41 H16 | | | | | | 292 | 153 | | | | | | | | | |
| INW 41 H26 | | | | | | | | | | | | | | | | |
| INW 51 A11 | 334 | 337 | 120 | 260 | 295 | 314 | 156 | 175 | 120 | 115 | 155 | 96 | 87 | 48 | G 2" | 83 |
| INW 51 A21 | | | | | | 346 | 188 | | 128 | | | | | | | |
| INW 51 H06 | | | | | | 314 | 153 | | 128 | | | | | | | |
| INW 51 H16 | | | | | | | | | | | | | | | | |
| INW 51 H26 | | | | | | 346 | 185 | | | | | | | | | |
| INW 51 H36 | | | | | | | | | | | | | | | | |
| INW 53 A21 | 334 | 337 | 120 | 260 | 295 | 365 | 191 | 175 | 128 | 115 | 155 | 96 | 87 | 48 | 55 | 83 |
| INW 53 H06 | | | | | 295 | 334 | 160 | | 120 | | | 96 | | | | |
| INW 53 H16 | | | | | 195 | 365 | 191 | | 128 | | | 96 | | | | |
| INW 53 H26 | | | | | 275 | 365 | 191 | | 128 | | | 94 | | | | |
| INW 53 H36 | | | | | 295 | 365 | 191 | | 128 | | | 96 | | | | |
| INW 61 | 363 | 365 | 120 | 290 | 325 | 353 | 190 | 190 | 156 | 140 | 180 | 76 | 95 | 54 | G 2" | 83 |
| INW 71 H06 | 382 | 384 | 125 | 290 | 325 | 377 | 185 | 198 | 128 | 140 | 180 | 84 | 109 | 54 | G 2" | 83 |
| INW 71 H16 | | | | | | | | | | | | | | | | |
| INW 71 H26 | | | | | | 411 | 190 | | 135 | | | | | | | |
| INW 71 H37 | | | | | | 432 | 211 | | 148 | | | | | | | |
| INW 73 | 360 | 366 | 122 | 284 | 325 | 387 | 191 | 197 | 128 | 140 | 180 | 84 | 109 | 54 | G 2" | 83 |
| INW 73 H37 | 382 | 384 | 125 | 290 | 325 | 432 | 209 | 198 | 148 | 140 | 180 | 84 | 109 | 54 | G 2" | 83 |

INW 01-84_ Einstufige Verdichter / Vakuumpumpen mit Seitenkanal
Maßangaben

Seite 2 von 3

| Baureihe | ø R | S | U | V | V' | V1 | V1' | W | ø X | Y x Z | X - Löcher |
|------------|-----|-----|---------|-----------|-----------|-----------|-----------|----|-----|----------|--------------|
| INW 01 | 8,5 | 2 | M6 x 18 | - | - | M16 x 1,5 | - | 29 | 115 | M6 x 20 | 0°/120°/240° |
| INW 11 | 8,5 | 2 | M6 x 18 | - | - | M16 x 1,5 | - | 29 | 126 | M6 x 20 | 0°/120°/240° |
| INW 21 | 10 | 2,5 | M6 x 17 | M6 x 1,5 | M25 x 1,5 | M25 x 1,5 | M16 x 1,5 | | 140 | M6 x 15 | 0°/120°/240° |
| INW 31 | 12 | 3 | M8 x 17 | - | - | - | - | | 158 | M6 x 15 | 0°/120°/240° |
| INW 41 | 12 | 3 | M6 x 19 | M6 x 1,5 | M25 x 1,5 | M25 x 1,5 | M16 x 1,5 | | 174 | M6 x 15 | 0°/120°/240° |
| INW 51 | 14 | 4 | M8 x 17 | M16 x 1,5 | M25 x 1,5 | M25 x 1,5 | M16 x 1,5 | | 200 | M8 x 20 | 0°/120°/240° |
| INW 53 | 14 | 4 | M8 x 17 | M16 x 1,5 | - | M25 x 1,5 | M16 x 1,5 | 29 | 200 | M8 x 20 | 0°/120°/240° |
| INW 53 A21 | 14 | 4 | M8 x 17 | M16 x 1,5 | - | - | - | 29 | 200 | M8 x 20 | 0°/120°/240° |
| INW 61 | 15 | 4,5 | | | | | | | | M10 x 20 | 0°/120°/240° |
| INW 71 H06 | 15 | 4,5 | | | | | M10 x 20 | | 240 | M10 x 20 | 0°/120°/240° |
| INW 71 H16 | | | | | | | | | | | |
| INW 71 H26 | | | | M32 x 1,5 | M32 x 1,5 | M32 x 1,5 | M32 x 1,5 | | | | |
| INW 71 H37 | | | | | | | | | | | |
| INW 73 | | | | | | | | | | | |

| Baureihe | A | A' | B | B' | B ₁ | C | C' | D | E | F | F' | F'' | G | H | H' | J | K | L | M | M' |
|-----------------|-----|----|-----|-----|----------------|-----|-----|-----|-----|-----|-----|-----|-----|-----|----|-----|-----|-----|-----|----|
| INW 81 H07 | 451 | - | 461 | 509 | - | 152 | - | 356 | 394 | 433 | 450 | - | 230 | 240 | - | 148 | 170 | 217 | 124 | 2 |
| INW 81 H17, H27 | | - | | | | | | | | | 477 | - | 247 | | - | 167 | | | | |
| INW 83 H07 | 451 | - | 461 | 509 | - | 152 | | | | 449 | 456 | - | 230 | 240 | - | 148 | | | 139 | |
| INW 83 H17, H27 | | - | | | - | | | | | | 492 | - | 247 | | - | 167 | | | | |
| INW 84 H27 | 500 | - | 550 | - | - | - | 336 | 356 | 394 | 589 | - | - | 247 | 300 | - | 167 | 170 | 217 | - | - |
| INW 84 H37 | | - | | | | 336 | - | | | 694 | - | - | 318 | | - | 197 | | | 312 | - |

| Baureihe | N | N' | O | ø P | Q | ø R | S | T | U | V | W | ø X | Y+Z | X - Löcher |
|-----------------|-----|----|-----|-------|---|-----|----|---|---|---------------|----|-----|----------|--------------|
| INW 81 H07 | 149 | - | 65 | G 2½" | - | 15 | 6 | - | - | 4 x M32 x 1,5 | 42 | 286 | M10 x 35 | 0°/120°/240° |
| INW 81 H17, H27 | | - | | | - | | | - | - | | | | | |
| INW 83 H07 | 164 | - | 65 | | | | | | | 4 x M32 x 1,5 | 42 | | | 0°/120°/240° |
| INW 83 H17, H27 | | - | | | | | | | | | | | | |
| INW 84 H27 | 261 | - | 125 | | | | 66 | | | 4 x M32 x 1,5 | 42 | | M12 x 20 | |
| INW 84 H37 | 212 | - | 165 | | | | | | | 4 x M40 x 1,5 | 54 | | | |

INW 01-84_Einstufige Verdichter / Vakuumpumpen mit Seitenkanal

Maßangaben

Seite 3 von 3

INW 01 > INW 73

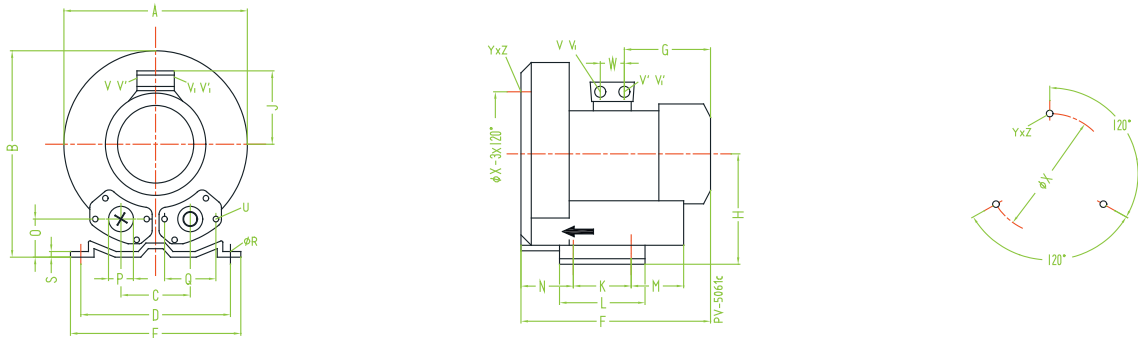

INW 81 > INW 83

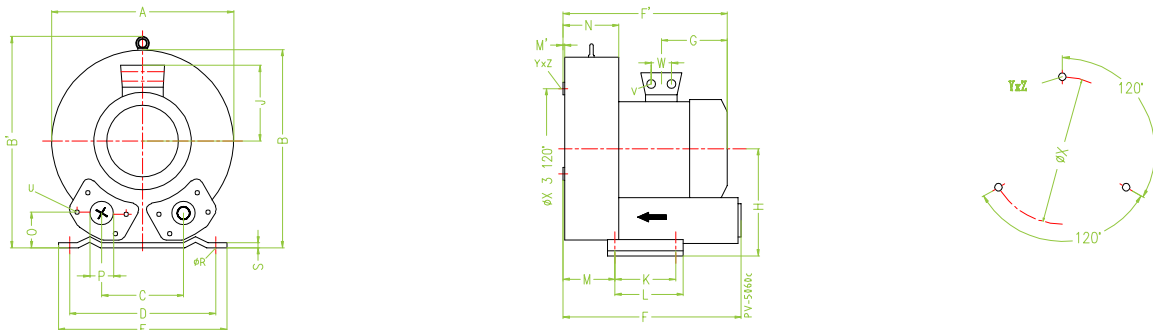

INW 84 H37

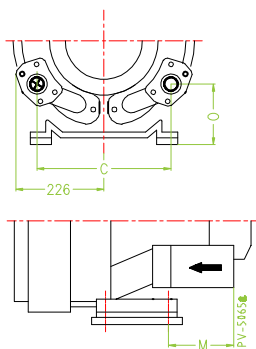

INW 84 H27

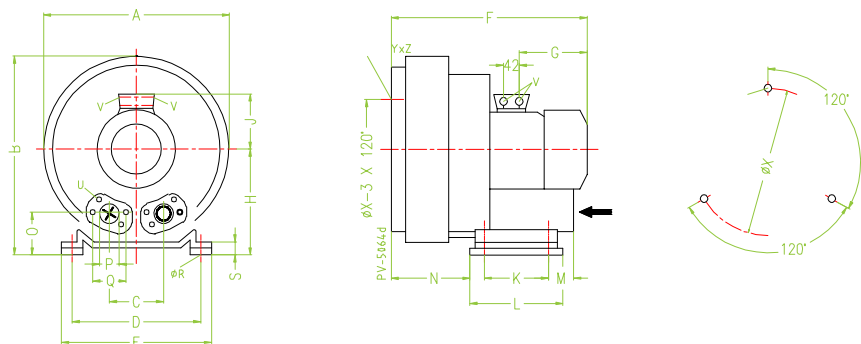

INW 91-95_ Einstufige Verdichter / Vakuumpumpen mit Seitenkanal

Maßangaben

Seite 1 von 2

| Baureihe | A | A' | B | B' | B ₁ | C | C' | D | E | F | F' | F'' | G | H | H' | J | K | L | M | M' |
|-----------------|-----|----|-----|----|----------------|-----|----|-----|-----|------|-----|-----|-----|-----|----|-----|-----|---|----|----|
| INW 91 H07 | 550 | - | 569 | - | 55 | 207 | 15 | 360 | 414 | 525 | 644 | 605 | 268 | 300 | - | 167 | 533 | - | 39 | - |
| INW 91 H17, H37 | | - | | - | | | | | | 611 | | | 345 | | - | 197 | | - | | - |
| INW 93 H07 | | - | | - | | | | | | 563 | 663 | 624 | 490 | | - | 167 | | - | | - |
| INW 93 H17, H37 | | - | | - | | | | | | 648 | | | 345 | | - | 197 | | - | | - |
| INW 94 H27, H37 | 615 | | 657 | | 16 | 207 | 15 | 360 | 415 | 752 | 786 | | 345 | 350 | | 197 | 533 | | 39 | |
| INW 95 H27, H37 | 610 | | 732 | | | 307 | | 490 | 526 | 1180 | 848 | 578 | 291 | | | | | | | |

| Baureihe | N | N' | O | ø P | Q | ø R | S | T | U | V | W | ø X | Y+Z | X - Löcher |
|-----------------|-----|----|-----|-----|-----|-----|----|---|----------|---------------|----|-----|------------|--------------|
| INW 91 H07 | 89 | - | 93 | 100 | 150 | 15 | 22 | - | M12 x 35 | 4 x M32 x 1,5 | 42 | 490 | M12 x 30 | 0°/120°/240° |
| INW 91 H17, H37 | | - | | | | | | - | | 4 x M40 x 1,5 | 54 | | | |
| INW 93 H07 | 127 | - | | | | | | - | | 4 x M32 x 1,5 | 42 | | | |
| INW 93 H17, H37 | | - | | | | | | - | | 4 x M40 x 1,5 | 54 | | | |
| INW 94 H27, H37 | 230 | | 150 | 100 | 140 | 15 | 71 | | M12 x 35 | 4 x M40 x 1,5 | 54 | 490 | M12 x 30 | 120°/60°/60° |
| INW 95 H27, H37 | | | | 219 | 201 | | 58 | | M8 x 40 | 4 x M40 x 1,5 | 54 | | M12 x 10.5 | |

INW 91-95_Einstufige Verdichter / Vakuumpumpenmit Seitenkanal

Maßangaben

Seite 2 von 2

INW 91 > INW 93

INW 94

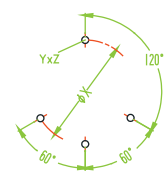
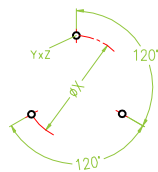
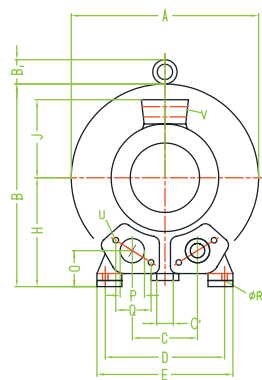
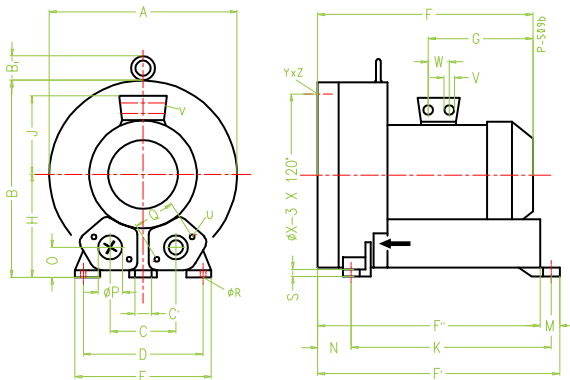

INW 95

